

Article number: 12347000120110
Description: KLEE-coil 347 000 120.110
M 12 Hardened/zinc-plated Blue

Measures

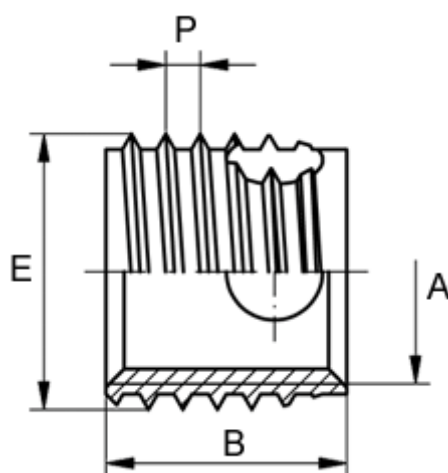

Female thread A	= M12
Length B	= 12
Male thread E	= 14.0
Min hole depth blind hole	= 15
Pre-drilled max	= 13.5
Pre-drilled min	= 13.2
Thread pitch P	= 1.75
Type	= 347 000 120 ...